

**Affordable Home  
Improvements  
London Ltd**

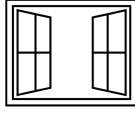

**MaxiLite**

**PVC-U & Aluminium Windows Doors - Fabricator & Installer South London**

Showroom: Unit 7, Roman Industrial Estates, Croydon CR0 2DT

[www.AffordableGlazing.co.uk](http://www.AffordableGlazing.co.uk) Mob: 07852636300

**Less bars, more light**

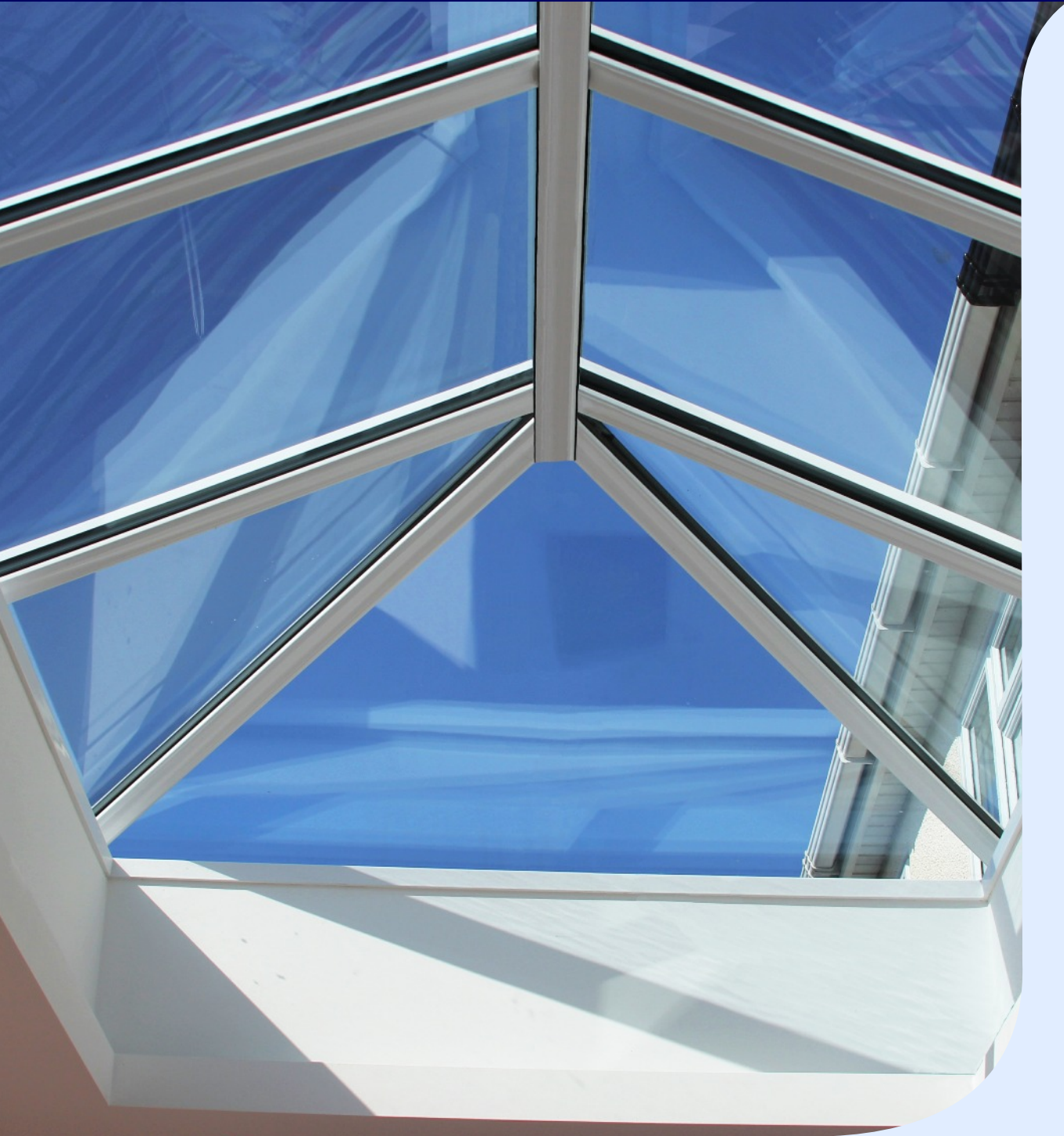

## **Maxilite Aluminium Roof Lanterns**

Slimmer, stronger and now with more standard colours, the all new Maxilite roof lantern

# Maxilite Range

MaxiLite

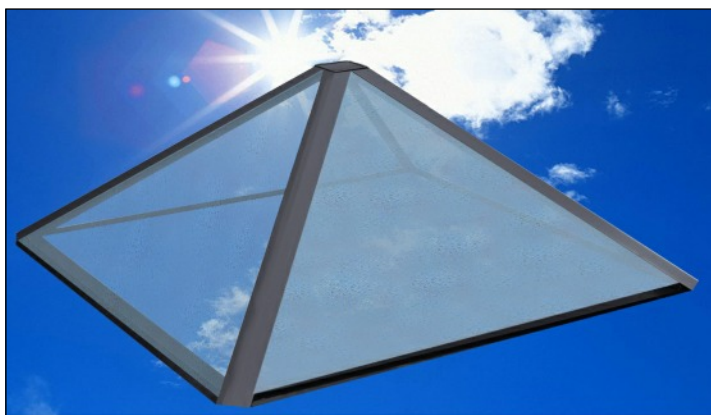

## Maxi-pyramid

- ▶ Five standard colours
- ▶ Available in both double and triple glazed options
- ▶ No ridge and just four hip beams
- ▶ Maximum size is 2.5m x 2.5m
- ▶ Designed to fit onto a square opening



## Maxi-flat

- ▶ Five standard colours
- ▶ Available in both double and triple glazed options
- ▶ No visible bars on show internally
- ▶ Maximum size is 1.2m x 2.5m
- ▶ Walk on options available



## Maxi-hipped

- ▶ Five standard colours and special order finishes
- ▶ Available in both double and triple glazed options
- ▶ No radius ends, slim profiles and just a 60mm ridge
- ▶ Maximum size is 3m wide x any length
- ▶ Made up ready to fit option



## Maxi-sky

- ▶ Five standard colours and special order finishes
- ▶ Available in both double and triple glazed options
- ▶ Maximum light with minimal bars
- ▶ Maximum size is 2.3m x any length
- ▶ Low pitch, wide spans and minimal bars

## Glass technology

We glaze all of our roofs with argon gas filled unit. The outer pane has a heat reflective coating which reflects 60% of the sun's heat away from your house, yet also retains heat in the building during colder periods, reducing heating bills.

### Self Cleaning glass

All of the MaxiLite roof lanterns come glazed with self cleaning glass as standard. The outer pane of glass is permanently bonded with a self clean coating which prevents the build up of dirt. When it rains the dirt is dispersed, leaving the glass clean and free of marks.

### Argon Gas Filled as standard

All units are filled with argon gas. Argon is 35% more thermally efficient than air as an insulator. Although argon gas makes the sealed unit more expensive to manufacture it improves its insulation properties by up to 30% over standard air filled units.

### Soft Coated low Energy Glass

We only use Low energy soft coated glass in MaxiLite roofs. This has benefit of reflecting the external heat of the sun during hot days and also reflecting the heat produced from your homes central heating back into your home when its cold, keeping your heating bills down and reducing CO emissions.

### 44mm Triple Glazed Units \*

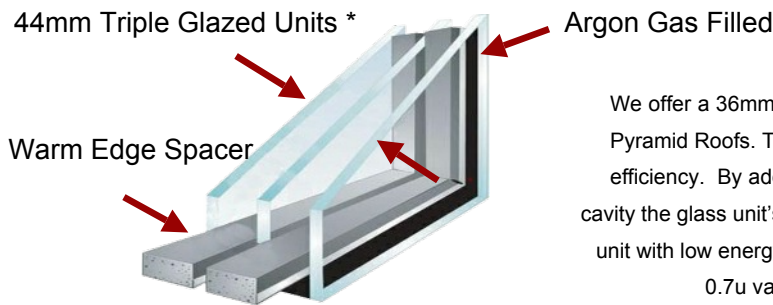

### Triple Glazing Option

We offer a 36mm triple glazed roof glass option, for the Maxi Hipped, Maxi Sky and Maxi Pyramid Roofs. The Maxi Flat has a 44mm triple glazed sealed unit for increased thermal efficiency. By adding an additional layer of low energy glass and an additional argon gas cavity the glass unit's efficiency improves by more than 80%. A triple glazed argon gas filled unit with low energy glass and a warm edge spacer bar has a thermal transfer rating of just 0.7u value, a standard double glazed sealed unit has a thermal rating of 2.4uv.

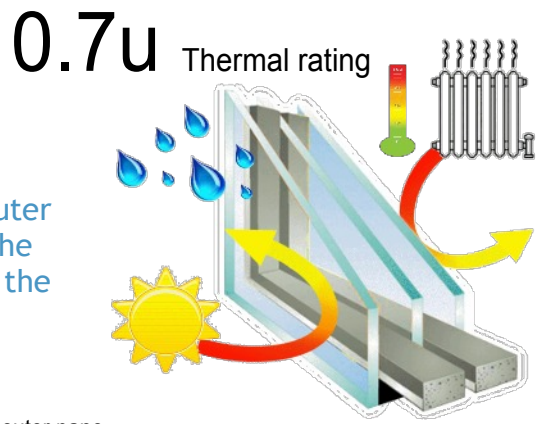

### Toughened Safety Glass

All MaxiLite roofs are glazed with toughened safety glass as standard. Toughened glass is physically and thermally stronger than regular glass. The glass is tempered at high temperatures allowing it to withstand greater loads. The tempering also makes it safer to use in roof applications. In this load test, carried out at our factory, we lowered seven 25kg bags of ballast onto a double glazed unit. Please note this is not a walk on roof.



### Glass Specifications

Tints		U Value Double Glazed	U Value Triple Glazed	Solar Heat Reflection DG	Solar Heat Reflection Triple	Self Clean Coating
Clear		1.2v	0.7u	60%	70%	✓
Blue		1.2u	0.7u	60%	70%	✓
Aqua		1.0u	0.7u	78%	82%	✓
Bronze		1.2u	0.7u	52%	73%	✓
Grey		1.2u	0.7u	60%	76%	✓
Privacy Glass		1.2u	0.7v	34%	35%	✓

\* Maximum unit thickness is 44mm on Maxi-flat and 36mm on Maxi-hipped and Maxi-pyramid

# Maxi-flat

MaxiLite



“Because less bars means more light”



Maximum Security



## Glass Lock

Maxi-flat glass cannot be removed

Maxi-flats unique glass lock system means that once the frame is clicked into place the glass can no longer be removed from the frame, making it one of the most secure lanterns available.

## Features

- ▶ Available in five standard colours or any RAL on special order
- ▶ Double and triple glazed options are available
- ▶ Maximum light with no bars visible internally
- ▶ Every roof custom made to order as standard
- ▶ Walk on roof option is available



All Maxi-flat lanterns are fitted with glass lock as standard





“ does your roof tick all the boxes ? ”

## 25 year powder coat warranty

Maxi-flat aluminium powder coated frame is maintenance free 

Wide standard colour range 



Black 9005



White 9003



Agate Grey 7040



Anthracite Grey 7016





Brown 8016

44mm Units 

Argon Gas Filled

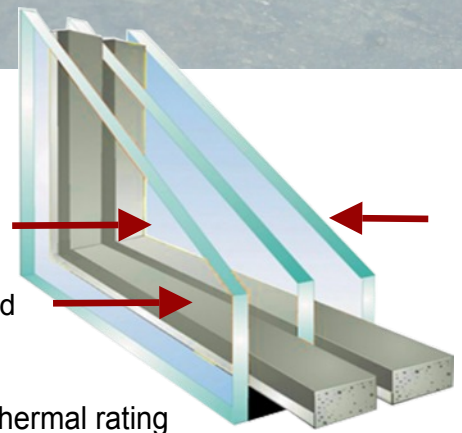
0.7u Thermal rating



- ▶ Thermally broken aluminium frame
- ▶ All Maxi-flats comes with glass lock as std.
- ▶ No visible bars on show internally
- ▶ Maximum light transmission
- ▶ Walk on option available 

# Maxi-pyramid

Maxi-pyramid lanterns do not require a ridge

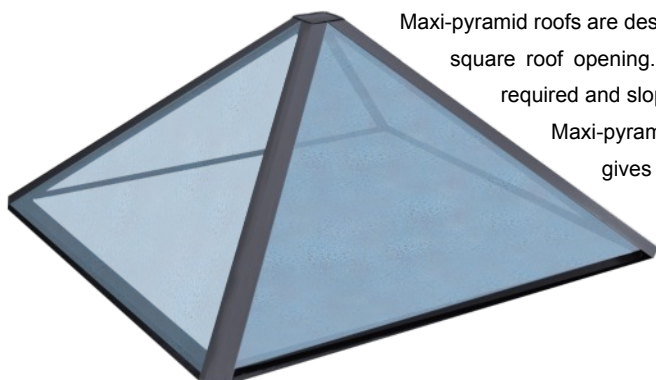

Maxi-pyramid roofs are designed to fit onto a square roof opening. With no ridge required and sloping on all sides the Maxi-pyramid roof system gives the maximum possible glass area with minimum obstruction.



# Maxi-hipped

MaxiLite



“ does your roof tick all the boxes ? ”

## Super Slim

The maxi-hipped roof uses super slim bars

With a ridge width of just 60mm, no bulky radius ends and eliminating the need for jack rafter supports, the Maxi-hipped roof system is one of the slimmest roof lanterns on the market today. Using powder coated aluminium caps externally Maxilite lanterns have a life expectancy of 25 years.

External Aluminium



Thermally Broken



Powder Coated 25 year life



Slim Line Profiles throughout

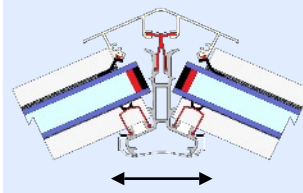

Ridge Width Just 60mm

- No Radius Ends
- No PVC external Caps
- No wide profiles
- No bulky ridges
- No Chunky caps





# MaxiLite

0.7u Thermal rating

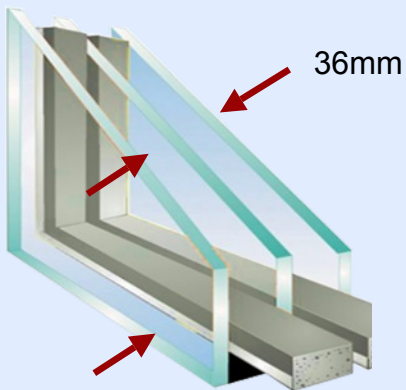

Argon Gas Filled

- Toughened safety glass
- 36mm thick units
- Argon gas filled
- Self cleaning as standard
- Range of glass tints available



Wide Range of Standard Colours



Black 9005

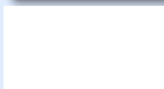

White 9003



Agate Grey 7040



Anthracite Grey 7016



Brown 8016

Slim aluminium profiles, no bulky PVC

